



ASSEMBLY & OPERATIONS MANUAL

H-TS and **H-BLUETOOTH**



ph:714.850.9716 • 800.237.2271

1411 E. Wilshire Ave., Santa Ana, CA 92705 • versaclimber.com • info@versaclimber.com

VersaClimber is proudly manufactured in USA by Heart Rate Inc. All Rights Reserved 2024



————— **TABLE OF CONTENTS** —————

	<u>Page</u>
Introduction.....	1
Exercise Tips / Guidelines.....	2-3
VersaClimber Specifications.....	4
VersaClimber Assembly Instructions.....	5-11
Tablet Operation.....	12-20
Mounting Smart Phone.....	21
Mounting Tablet.....	22
Stepping On / Starting Workout.....	23-24
Routine Maintenance.....	25-27
Warranty.....	28

INTRODUCTION

Congratulations on the purchase of your new VersaClimber - The original total body climber for over 43 years! The VersaClimber provides a more complete, safe and overall better exercise than treadmills, ellipticals, steppers, running, cycling, swimming, rowing or cross country skiing because the VersaClimber works all the major muscles of the body in one safe, smooth rhythmic motion.

Climbing against gravity also burns more calories than any other exercise. VersaClimber accommodates all levels of fitness and ages because you can walk, jog, run, or sprint vertically at various stride lengths and running speeds.

With a simple positioning of the hands (holding on the side rails), your VersaClimber becomes a stepping machine to concentrate the work on the lower body. By having a stair stepper and climber all in one machine, you can change your workouts easily to keep you motivated and exercising toward your fitness goals.

The following pages will offer some guidelines to gain an understanding of the functions and multiple uses of the VersaClimber. These guidelines are not specific individual exercise prescriptions, but rather, general VersaClimber user information.

Most functions and their operation are applicable to both H-TS and H-Bluetooth VersaClimbers.

WARNING:
READ ALL INSTRUCTIONS CAREFULLY

**Before assembling or exercising on the VersaClimber,
READ THIS ASSEMBLY AND OPERATION MANUAL THOROUGHLY.
Instruct others how to use the machine in accordance with
procedure outlined in this manual.**

Consult your physician before beginning this or any other exercise program. This is especially important for individuals over the age of 30 and those that have known health problems. *HEART RATE INC., IS NOT RESPONSIBLE FOR PERSONAL INJURY OR PROPERTY DAMAGE SUSTAINED BY OR THROUGH THE USE OF THE VERSACLIMBER.*

**DO NOT OVER EXERT YOURSELF! IMMEDIATELY DISCONTINUE
THIS OR ANY OTHER EXERCISE IF YOU FEEL FAINT, DIZZY,
SHORTNESS OF BREATH OR ANY OTHER PHYSICAL DISCOMFORT.**

TYPE OF EXERCISE CLIMBING

The VersaClimber is a full body, smooth, non-impact climbing exercise that uses most of the major muscles in the body. The VersaClimb exercise incorporates one of the most natural activities to which the body can be subjected—vertical climbing. The VersaClimber incorporates a push/pull motion with the right arm and right leg approaching each other, while the left arm and left leg separate. As the motion alternates, a simulated vertical running motion is reproduced. Vertical running exercises the muscles in the arms, chest, shoulders and back of the upper body in addition to the lower body.

STEPPING

The hand rails transfer the lower half of the total body machine into a stepper. Stepping concentrates the work on the lower body; the glutes, quadriceps, hamstrings, shins, and calves. Without any machine adjustments, the user can change exercises from stepping to climbing by moving the hands from the rails to the moving hand grips. The VersaClimber utilizes four fundamental exercise modalities: **Aerobic** and **Anaerobic** training for cardiorespiratory improvements. **Strength** and muscular **Endurance** for dynamic health.

INTENSITY

Based on the general population, the intensity of your workout should be maintained at 70% to 85% of your maximum heart rate unless advised otherwise by your doctor.

To calculate your target heart rate take $220 - \text{Age} \times 70\% \text{ to } 85\% = \text{Target Heart Rate}$. It is always important for beginners to exercise at very low levels and to warm up and cool down no matter at what intensity you begin.

Heart Rate Training Values For Healthy 45 Year Old:

$220 - 45 = 175 \times 60\% = 105$ (Beginner Target Heart Rate)

$220 - 45 = 175 \times 70\% = 123$ (Intermediate Target Heart Rate)

$220 - 45 = 175 \times 85\% = 149$ (Advanced Target Heart Rate)

If perceived exercise is used to establish a work intensity:

–A beginner may want to begin at an intensity which is approximately equal to a brisk walk.

–An intermediate may want to begin at an intensity which is approximately equal to a jog.

–An advanced athlete may want to begin at an intensity that is approximately equal to a run.

DURATION

The duration of the workout depends on your level of conditioning and the intensity of the workout. Normally 15 to 30 minutes continuous climbing or stepping is average, which includes 5 - 10 minutes of warm up and 5 - 10 minutes of cool down. These periods should be at a comfortable easy pace. As you become an advanced or elite climber, the duration of your workout can increase to an hour or more.

FREQUENCY

The frequency of your workout should be 3 to 5 exercise sessions per week, depending on the capacity of the individual. It may be beneficial to alternate a day of climbing with a day of rest until you fully adapt to the exercise.

RATE OF PROGRESSION

The rate of progression is determined by the intensity and the duration of your exercise program. The user should be fully adapted to and comfortable with their workout level before increasing the intensity and duration. While some people may be considered to be in "good condition" because they are already engaging in an exercise program, it is recommended that the user climb for at least 3 weeks before progressing to the next level. As a general rule, adaptation to conditioning takes an additional week for each 10 years of age after the age of 30.

***THOSE INDIVIDUALS WHO HAVE ANY HEALTH PROBLEMS MUST
HAVE THEIR EXERCISE PROGRAMS MODIFIED AND MONITORED
BY THEIR PHYSICIAN.***

NOTE:

**TO MAINTAIN TRAUMA FREE MOTION, IT IS MANDATORY THAT YOU DO NOT,
UNDER ANY CIRCUMSTANCES, "BOTTOM OUT" AT THE END OF EACH STROKE.
ALSO, DO NOT HIT THE STEP HEIGHT LIMITERS WHEN THEY ARE IN USE.**

SPECIFICATIONS

PHYSICAL CHARACTERISTICS

	H-TS	H-BLUETOOTH
Height	7 Feet 6 Inches (90 inches)	SAME
Required Floor Space	36 Inches x 44 Inches	SAME
Weight	78 pounds	SAME
Structural	Aluminum and Steel	SAME
Sliding and Rollings Bearings	Lubricant Filled Nylon	SAME
Moving Hand Grips	2	SAME
Stationary Handrails	2	SAME
Hand Grip Adjustment	4.5 increments	SAME
Foot Pedals	2 Aluminum, 5 inches x 9 inches	SAME
Foot Pedal Straps	Velcro	SAME
Foot Pedal Adjustments	3.25 inches	SAME
Leveling Adjustments	3	SAME

FUNCTIONAL FEATURES

Climb Angle	75 degrees	SAME
Vertical Lift Factor	96.6 percent	SAME
Climb Rate	0 feet to Unlimited	SAME
Step Height/Stroke Length	0 to 20 inches	SAME
Body Motion	Arms and Legs, Legs, Arms	SAME
Minimum Height to Climb	4ft. 11 inches and taller	SAME
Climber's Weight	70-300lbs.	SAME
Age and Sex	Any	SAME
Level of Fitness	Beginner to Elite Athlete	SAME

*Specifications may change without prior notice at the sole discretion of the manufacturer.

———— **VERSACLIMBER ASSEMBLY INSTRUCTIONS** ————

IF YOU HAVE ANY QUESTIONS AFTER YOU HAVE THOROUGHLY READ THE ASSEMBLY INSTRUCTIONS, CALL 714-850-9716 x226 AND ASK FOR SERVICE.

Your VersaClimber comes partially assembled. Please read these assembly instructions thoroughly before setting up your VersaClimber. Clear an area away from any objects that might restrict your motion while setting up. A **FLAT, LEVEL, NON-SLIP SURFACE IS NECESSARY TO ENSURE ITS STABILITY.** It is suggested, for safety reasons, that two able body persons assemble the machine.

TOOLS REQUIRED FOR ASSEMBLY

- (One) 3/16" hex key wrench (provided)
- (Two) 1/2" open end or socket wrench *
- (Two) 9/16" open end or socket wrench *
- (One) 3/4" open end wrench *

*Adjustable crescent wrenches can be used in place of open-end wrenches.

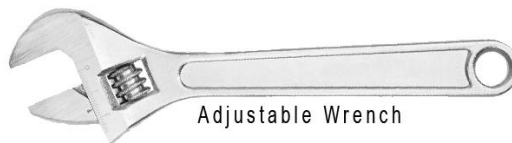
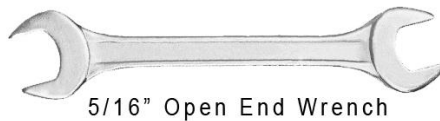

PARTS LAYOUT

1. 00076 (1) - SCREW, HX HD 3/8-16 x 1-3/4 GD 5CP
00001 (1) - NUT, HEX, ESNA LOCK 3/8-16 PLATED
2. 00039 (1) - NUT, 3/8-16 ESNA S.S. HEX LOCK
3. 00081 (6) - LOCK NUT, ESNA 5/16-18 BLK ZNC
4. 00099 (2) - SCREW, HXHD 5/16-18 x 1 1/2 BLK ZNC
5. 00236 (2) - SCREW, 5/16-18 x 3/4 HX HD BOLT BLACK
6. 00097 (2) - SCREW, FLHDSOC 5/16-18 x 1-1/2 BL Z
7. 00079 (2) - SCREW, FL HD SOC CAP 5/16-18 x 3/4

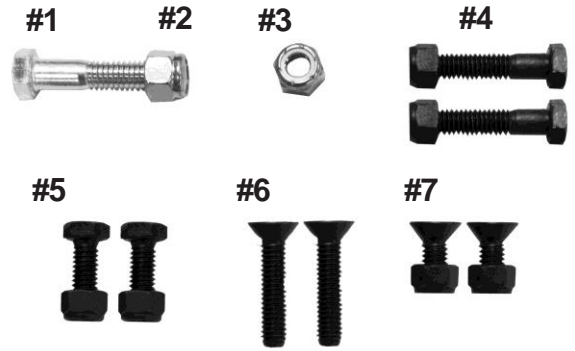

8. 065-04-000 (1) - Post
9. 060-06-000 (1) - Handle, Right Side
60-07-000 (1) - Handle, Left Side
10. 060-09-001 (1) - Handrail, Left Side
60-09-002 (1) - Handrail, Right Side
11. 060-09-003 (2) - Straight Rail
12. 101-04-000A (2) - Foot Pedals
13. 060-21-002 (1) - Base Plate
14. 00105 (2) - Knob & Pad
15. 060-01-003 (1) - Brace-Tie
16. 060-01-002 (1) - Brace
17. Tablet Display
18. Tablet Power Cord

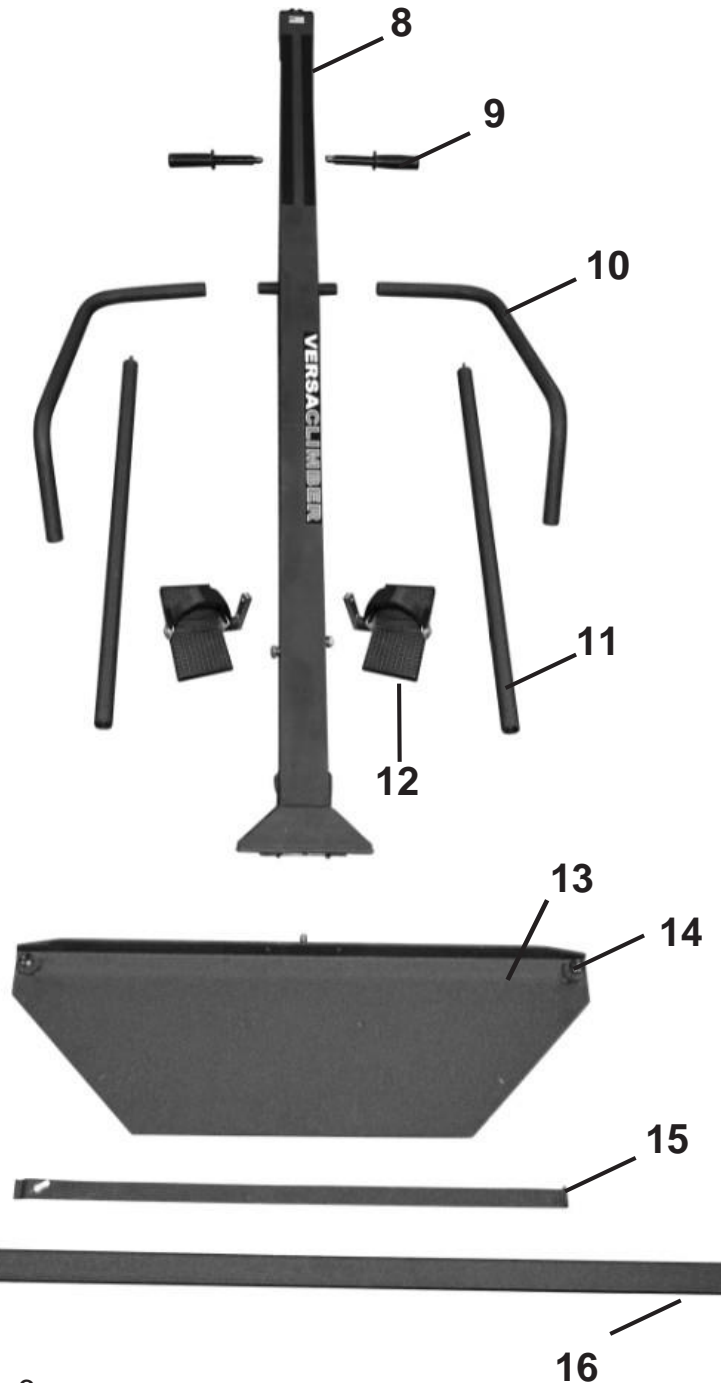

ATTACHING BASEPLATE

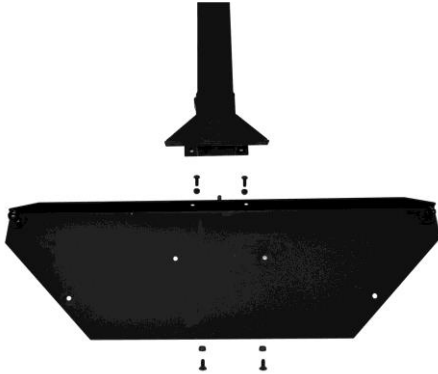

1. Line up post with baseplate as seen in picture. Hardware needed: Qty. (2) #5's (5/16 x 3/4" hex head bolt black), qty. (2) #7's (5/16 – 18 x 3/4" flat head socket screw), qty. (4) #3's (5/16 – 18 black lock nut).

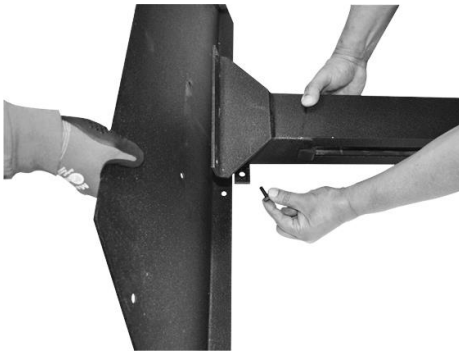

2. Place baseplate onto post. With (2) #5's, run the screw from the backside through the baseplate and post. Apply (2) #3's per screw threading nut onto bolt but leave loose. Now run the other bolt on the other side of the post through the baseplate and post, leaving loose.



3. With (1) #7, run the screw through the baseplate, through the post. Apply (1) #3 loosely. Apply the other #7 through the baseplate and post and apply another #3 loosely.

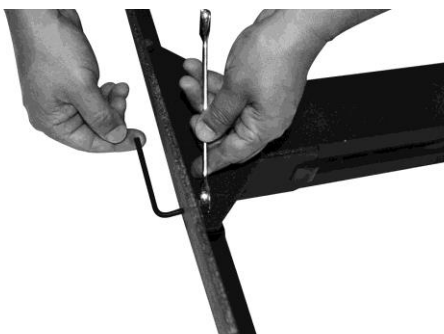

4. Attach hex key wrench to #7. Then attach 1/2" open wrench to #3 on other side. Tighten. Repeat direction on the other side. With (2) 1/2" open wrenches, secure the (2) #5's and the (2) #3's on each side of the post. Tighten down base plate. Make sure all connections are tight.

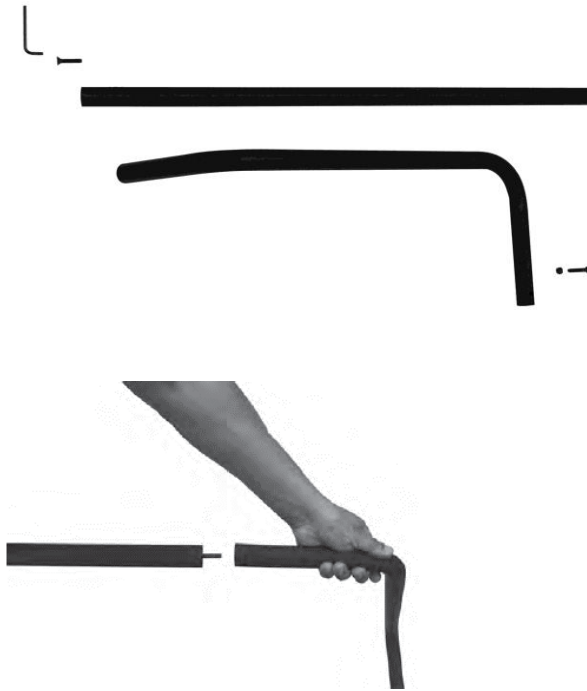

5. Preassemble the left side and the right-side handrails. Each handrail consists of one straight and one curved section. By hand, screw the two straight handrail sections into the two curved handrail sections and tighten securely.



6. Slide and attach assembled curved handrail bar to the receiving end on the post. Align bolt holes and insert bolt #4 and tighten #3 nut, together.



7. Attach the straight section of the handrail to the base plate, using the flat head screw #6, tighten with 3/16" hex wrench (provided).

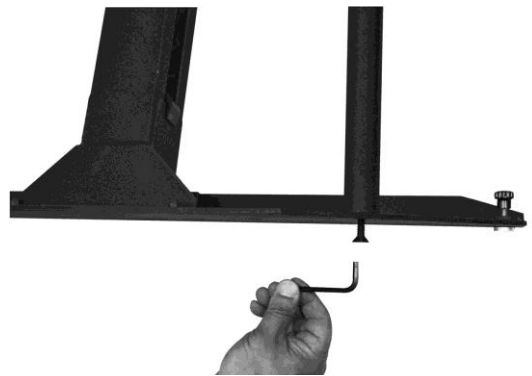

8. Tighten flat head screw with 3/16" hex wrench (provided).



9. Assemble the brace to the floor tie by screwing adjusting bolt into the brace. Screw the adjusting bolt in about halfway.



With another person holding it at a slight angle, assemble the brace and tie to the post.

Assemble the brace and tie to the post as shown here. This requires two people. Hold the post upright so that the base plate is on the floor, then attach the top of the brace with bolt and locknut.



Tighten securely.

13. Attach the tie with locknut to the bottom of the post. Tighten securely.

Position the machine on a solid flat surface. *Do not place the machine on a plastic sheet, throw rug or anything that may cause the machine to slip when in use.*

When you select a location for your machine, be sure that there is enough space around the machine for free movement of your arms and legs.

ATTACHING FOOT PEDALS

14. Four holes have been machined into the moving foot pedal bar. This allows the foot pedals to be positioned at a higher level, providing both visibility to the display module and handle grips access for smaller individuals as 4'11" tall.



Align the two holes on foot pedal assembly with the desired height on VersaClimber. **TIGHTEN FOOT PEDAL SECURELY** using 9/16 wrench.

NOTE:

CHECK THAT PEDALS ARE SCREWED IN TIGHT EVERY 2 MONTHS.

IT IS RECOMMENDED TO REPLACE FOOT PEDALS EVERY 3 YEARS.

Attach each foot pedal with the two bolts provided. You can adjust the foot pedal height by choosing a combination of bolt holes (as shown below) in the moving foot pedal bar. This will accommodate shorter or taller users. Shorter individuals set at position 1. Followed by 2, or 3. Most common setting for pedal is position 3.

NOTE: Make sure pedal "L" bracket is attached in the upright position. As seen below.

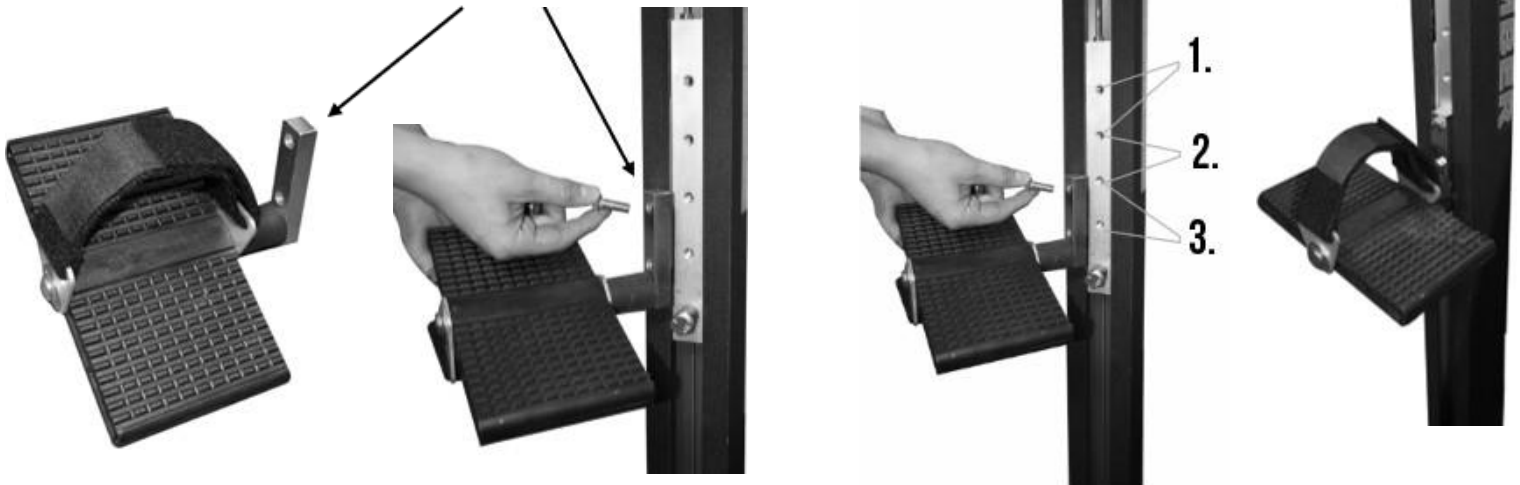

ATTACHING HAND GRIPS

NOTE:

The RIGHT SIDE HAND GRIP tightens COUNTER - CLOCKWISE.



Screw the left & right hand grips into upper threaded shaft holes. (**NOTE: left side grip tightens clockwise; right hand grip tightens counter-clockwise**). Hand tighten grips.



Adjusting Front to Back Movement

15. Adjust screw at the bottom of the angle brace “up or down” until base plate lays flat on the surface on which it is placed. Ideally, one person stands on front base plate, while 2nd person adjusts the brace and tie bolt.

Adjust screw for Front to Back movement, ensuring the baseplate is flat on the ground.

Make sure leveling knobs are fully retracted and flush with base plate before leveling.

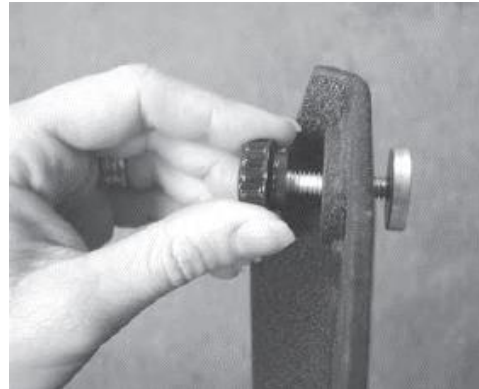

Rotate leveling knob up or down until base plate lays flat on the surface on which it is placed.

Rotate knobs down until each pad touches the floor. Adjust the two leveler knobs located on the base plate to level the machine right to left. *(If the machine is placed on a deep carpet, it may be necessary to readjust the two leveling knobs after two or three days of use.)*

Be sure that all assembly steps have been accurately and thoroughly completed. Be extra careful to ensure that all the nuts bolts are tight and that the foot pedals and hand rails are securely in place.

Note: There are three handle locations. As a general rule, screw hand grips into the holes at about shoulder height.

Tablet Operation

The power switch is on the right side of the touch screen. Press and hold it for 5 seconds

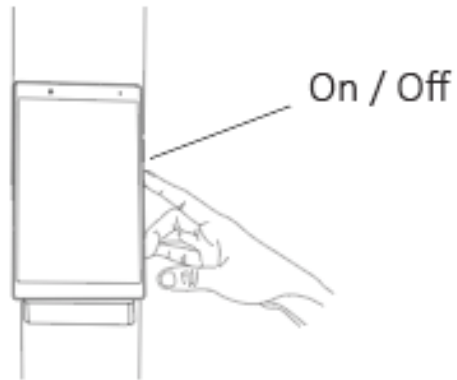

Connect to WIFI

Launch Screen

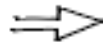
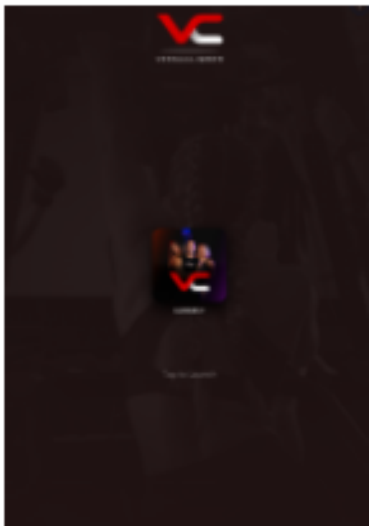

1. To access WIFI, from the RIGHT CORNER
Swipe down twice from the top.

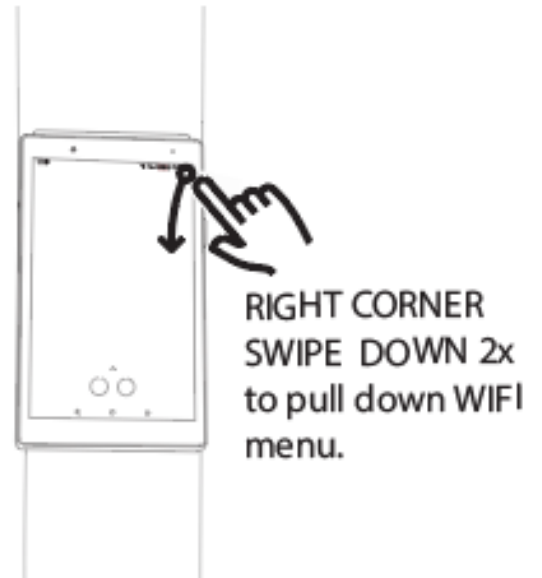

The first swipe brings up the time and the 2nd access to the WIFI.



The second swipe brings down internet settings.

2. Press and hold WIFI symbol.

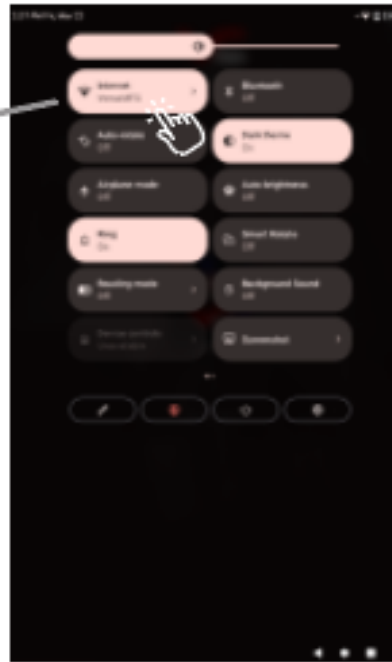

3. Locate WIFI Router. TAP to select.

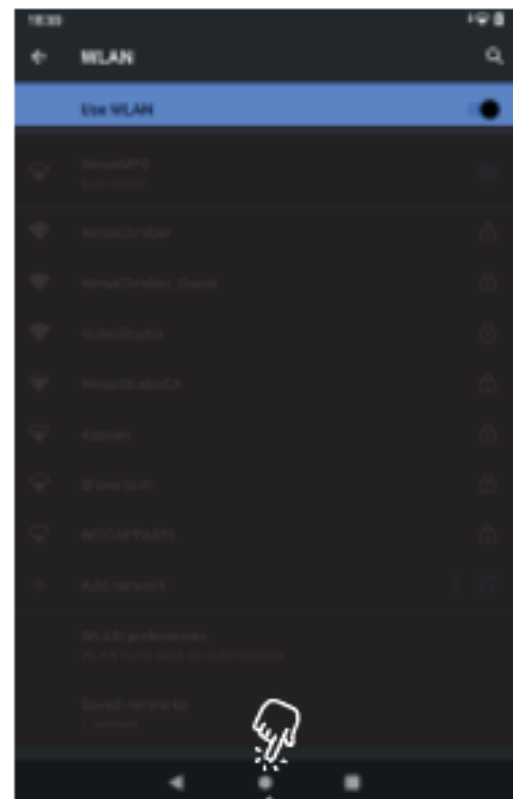
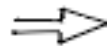
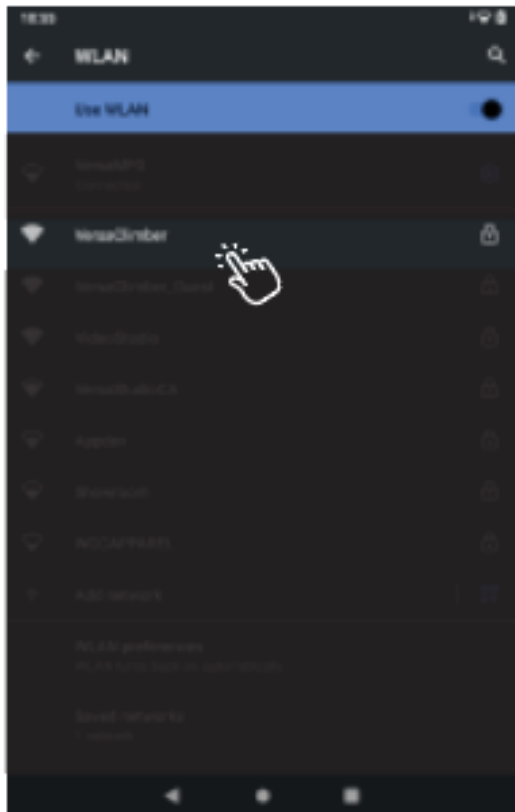

4. After selecting WIFI, TAP the circle icon (HOME button) at the bottom of screen, this will return back to TAP to launch screen.

Create an Account

TAP to launch

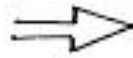
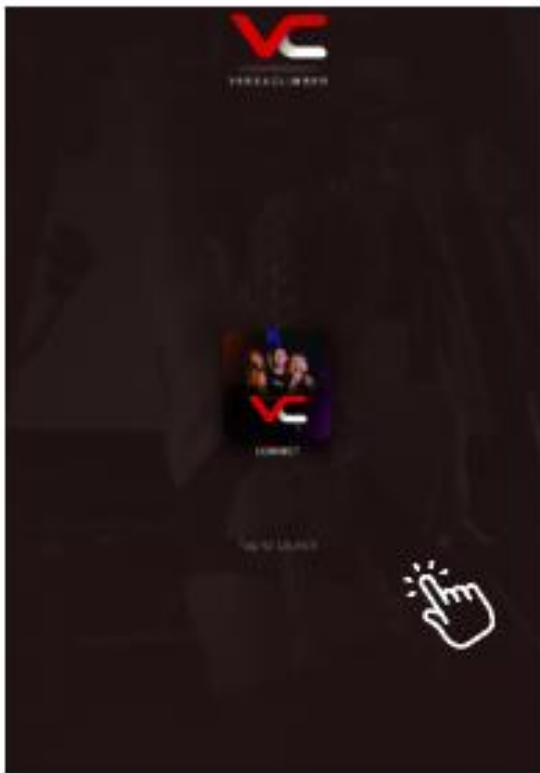

Tap ADD USER



The sign in / log in screen.



NOTE: If already registered, sign in with email & password.
Tap REGISTER to create an account.

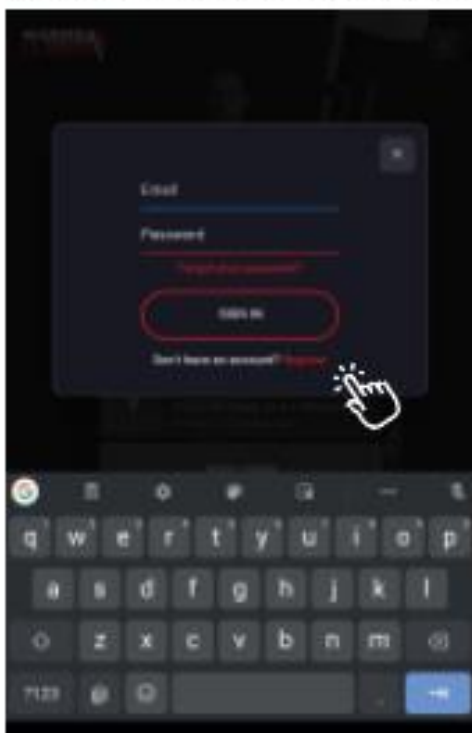

Complete the user profile fields.
Tap SIGN UP.

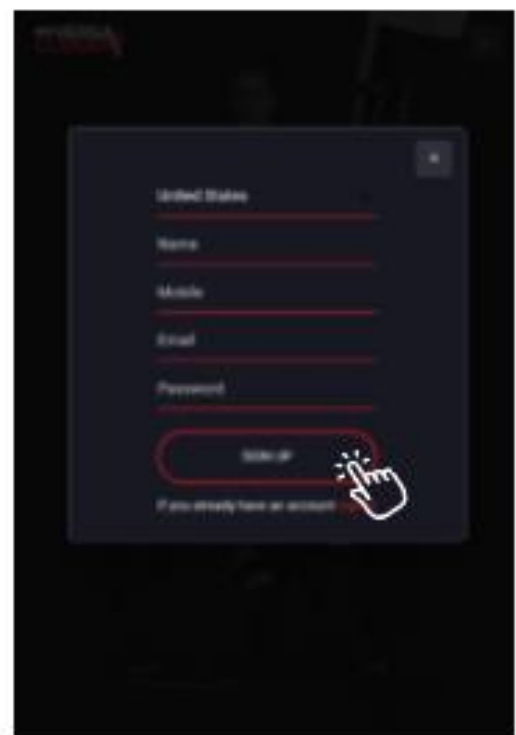

Home Screen

The Home Screen shows total stats for the week / all time.

The screenshot shows a dark-themed mobile app interface. At the top left is the 'VC' logo. The main content is organized into a grid of cards. The top-left card displays 'All time total feet climbed' as '370,530 ft'. Below it are four smaller cards showing weekly stats: '12 Weekly Climb', '219 Feet Climbed', '29.70 Calories', and '521 Watts'. A 'Foot Steps' bar chart is at the bottom left. On the right side, there are two class cards: 'QUICK HIT' and 'INTRO TO CLIMBING'. At the bottom right is a 'MONUMENTS' card. A red 'START' button is at the very bottom. Callout lines connect text labels to these specific elements.

All time total feet climbed

History of past workouts

Weekly calories

Weekly watts

Weekly workouts

Monthly subscription required. Access to 100's of LIVE and On-Demand training classes. Compete against other climbers via leaderboards.

Monument Challenges

To START WORKOUT



Workout Screen

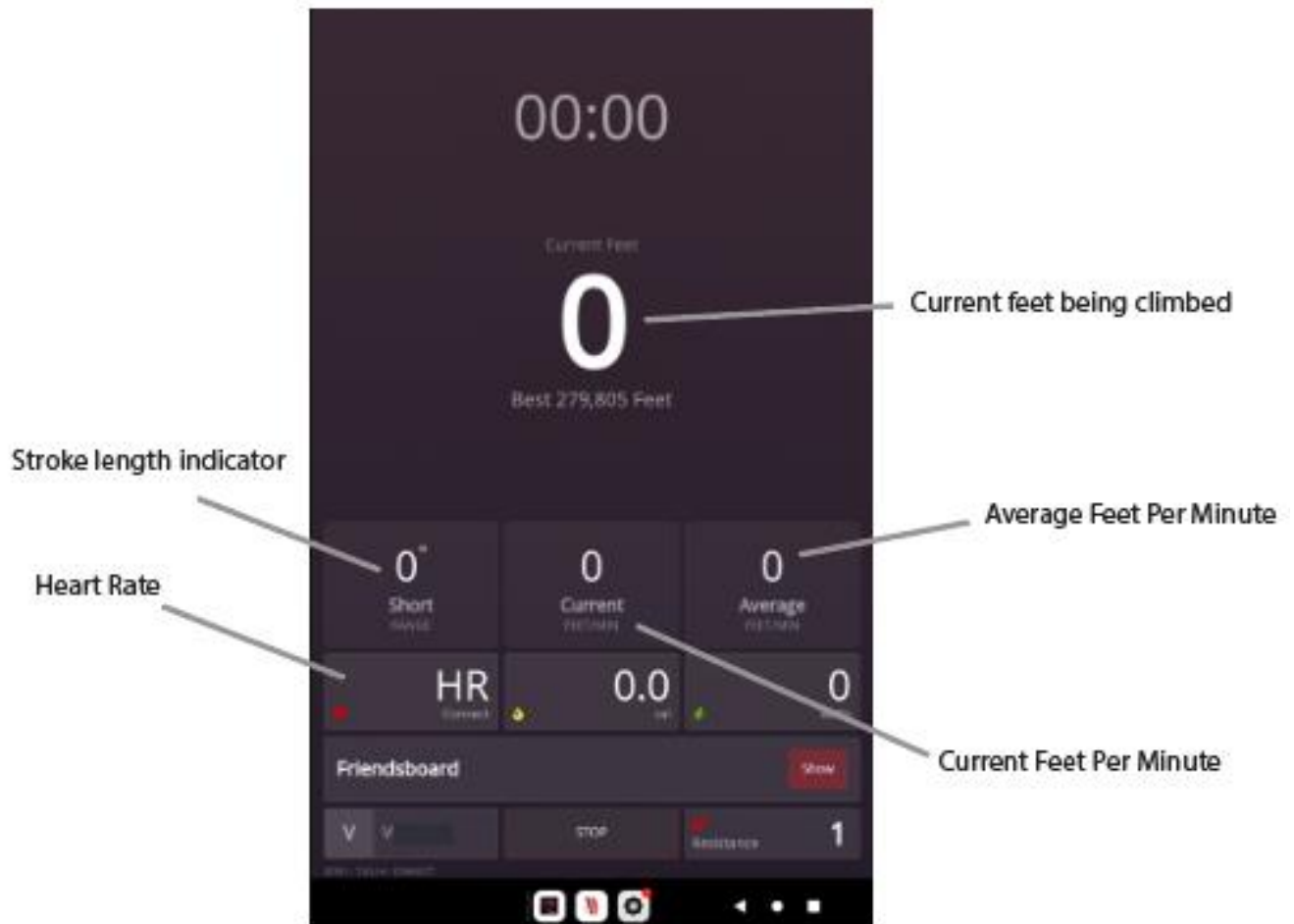

Stroke Length

Stroke length is now shown on the left with the height in inches at the top, and categorized as "short", "medium" or long". This goes along with how studios are coaching members on VersaClimbers around the country & world.

Average Feet Per Minute

Percent of Max is a learning-metric that is about you. The app monitors the max number of feet you can climb in a minute and remembers that as your max. Your current speed is shown as a percentage of your max. Why? this allows for zone-based training like what it done with heart rate.

Calories Burned

Calories are now shown and the amount you burn is a function of your speed and weight. By default it used the assumed weight of 160lbs. This can be changed by long-pressing the calories icon and entering your actual weight.

Save and Discard

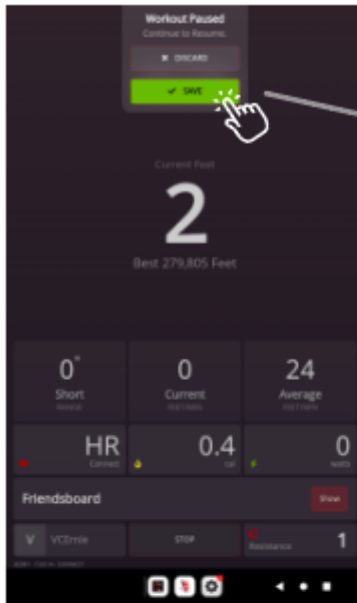

SAVE and Discard window will appear after 7 seconds of inactivity.

TAP Save

This will save your current workout - will automatically update the app.

TAP Discard

This will delete your recent workout - no information will be saved.

To View Past Workouts

To see PREVIOUS WORKOUTS
TAP the WORKOUTS link button
on the upper left:



Viewing Past Workouts (continued)

TAP past workout to view workout analytics.

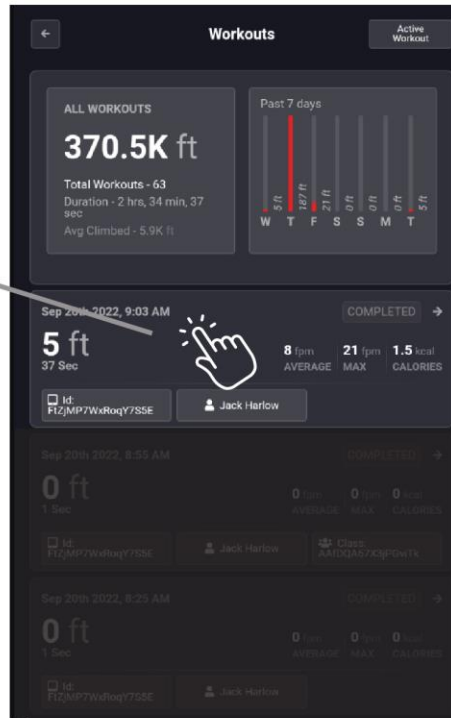

Stroke length
Short / Middle / Long

Feet Per Minute
Graph

Connecting Heart Rate Monitor

To set up heart rate:

1. Put on your chest strap heart rate monitor
2. Begin a workout on the VersaClimber
3. Tap the heart icon at the bottom of the workout recording screen and select your heart rate monitor

That's it! It will automatically look for your heart rate monitor on every workout thereafter.

*The app is compatible with any BLE heart rate monitor that is "open" (meaning, "no proprietary"). Garmin, Apple Watch, certain Polar straps, and some others WILL NOT WORK. If you search Amazon for "BLE Heart Rate Monitor" you will get a good idea of compatible straps.

Troubleshooting Guide

If you are having any problems try the following steps:

Symptom:

The touchscreen is on, but no data shows when you climb, try the following:

- 1) Press the lower left corner of tablet multiple times to reload app. You will see a number code that looks something like this: *b5f4a - 5.09.10 Force Reload 1/5*

Force Reload of app
(Tap once to bring up,
followed by 4 multiple
taps.

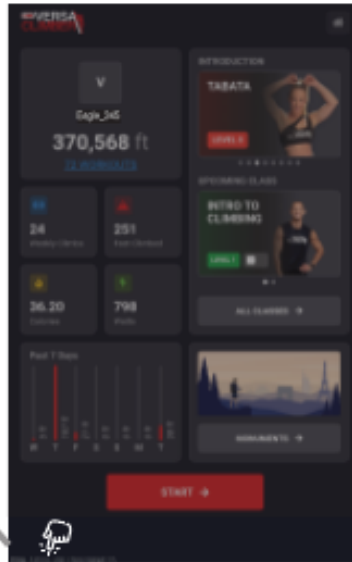

- 2) Power off the touchscreen, and then unplug power cord. Wait 15 seconds, then plug back in. Turn on tablet by pressing and holding the side power button.

Symptom:

If you are seeing the Offline Screen instead of the Online Screen

- 1) Be sure you are connected to WiFi. If it says "Saved" the password is wrong. If it says "Connected" then the password is right and it is connected.
- 2) Be sure that your wifi router is working and Internet is available.

Have questions?



Need to talk to us?
Call 1-800-237-2271



email us: support@versaclimber.com



MOUNTING SMART PHONE



1. The mounting bracket has the ability to hold tablets and smart phones. When mounting a phone, open the smaller interior side mounts.



3. Gently slide your smartphone into the mount holder. Apply even pressure to both sides of the phone to ensure a snug fit. Avoid forcing the phone into the holder.



2. Holding the phone bracket open, carefully slide your phone into the mounted phone holder. Align the bottom of your smartphone with the bottom of the holder. Ensure that the phone is centered and positioned vertically.



MOUNTING THE TABLET



1. Carefully slide your tablet into the tablet holder. Align the bottom of your tablet with the bottom of the holder and ensure that it is centered.



2. Use adjustable side clamps to secure your tablet in place. Ensure that your tablet is held firmly and does not wobble.



CHARGING THE TABLET

NOTE: It is recommended to remove tablet from mounting bracket when charging.

Remove tablet from mounting brackets, by releasing mechanism on the mount holder. Carefully lift the tablet out of the mount holder, ensuring that you do not damage the tablet or the holder. Plug the power cord into the charging port on your tablet. Plug the other end of the power cord into a power source, such as a wall outlet or a USB port on a computer. Allow your tablet to charge for the recommended amount of time. This will vary depending on the tablet model and the current battery level. Allow your tablet to charge for the recommended amount of time. This will vary depending on the tablet model and the current battery level. Once your tablet is fully charged, disconnect the power cord from the tablet and return to VersaClimber mounting bracket.

STEPPING ON

(Photo A) Support yourself by holding the stationary handrails. Always step on the lower pedal first, applying enough weight to bring it to its lowest position. While still holding onto the stationary handrails, step up onto the other pedal and bring the pedals to an even or level position. Select a hand position at approximately shoulder height (See Photo B). Adjust the hand grips, if necessary, by unscrewing both handles. Unscrew the handles by turning the bottom of the handle toward you while you are standing on the machine. Reposition both handles by screwing them in with the rotation of the bottom of the handles going away from you. Tighten so that the handles are secure.



Photo A. Step onto the pedal with enough weight to bring it to its lowest position.



Photo B. Select a hand position at approximately shoulder height.



Photo C. Begin climbing or stepping by taking a short 4-6 inch step.

START SLOWLY!
Take a shallow 4–6 inch step height.
(The average step height of a flight of stairs is only 7 inches)

Beginner or intermediate climbers,
SHOULD NOT
TAKE A FULL 20 INCH STEP
This step height is used by Advanced users.

**PICK A PACE YOU CAN MAINTAIN FOR
A MINIMUM OF 15 MINUTES.**



Photo D. Full 20 inch step

DO NOT OVER EXERT YOURSELF! IMMEDIATELY DISCONTINUE THIS OR ANY OTHER EXERCISE IF YOU FEEL FAINT, DIZZY, SHORTNESS OF BREATH OR ANY OTHER PHYSICAL DISCOMFORT.

FOOT POSITIONING



Photo C To develop your calves, climb on your toes.



Photo D Upper leg work can be achieved by climbing with the heel of your foot forward on the pedal.

Foot Positioning

The position of your foot on the pedals will allow you to focus the work on specific muscle groups. To concentrate the work in your ankles and calves, climb on your toes. See photo C. Quad work can be accentuated by climbing with the heel of your foot forward on the pedal. See photo D. The intensity of the work for the inner legs can be increased by pointing the toes inward. Turning the toes outward will work the outer legs. If tingling or numbness in the foot occurs, reposition the foot on the pedal (forward or back) until you are comfortable. Also check shoe laces and toe straps that may be too tight.

IT IS RECOMMENDED TO REPLACE FOOT PEDALS EVERY 3 YEARS.

WARNING:

*It is imperative that you consult your physician
Before engaging in any exercise program.*

CAUTION:

DO NOT OVER EXERT YOURSELF! IMMEDIATELY DISCONTINUE THIS OR ANY OTHER EXERCISE IF YOU FEEL FAINT, DIZZY, SHORTNESS OF BREATH OR ANY OTHER PHYSICAL DISCOMFORT.

CAUTION:

DO NOT LEAN BACK OR STRAIGHTEN THE ARMS BECAUSE THE MACHINE MAY BECOME UNSTABLE AND TIP OVER.

ROUTINE MAINTENANCE

The VersaClimber consists of a main frame post that is made of extruded aluminum. The post has two rectangular slots that run through the full length of the machine. The post is supported by a base plate and brace and floor tie that provide support for the machine. Two handrails also connect the post to the base plate.

The post has a pulley at the top and a spring loaded pulley at the bottom. Two hand grips and two foot pedals are part of the carriages and attached to cable that goes around two pulleys at the top and bottom of post. The carriages move up and down inside the post. The two hand grips and two foot pedals are screwed / bolted into the carriages. The carriages also have special molydisulfide filled nylon rollers and slide bearings to provide a smooth motion for the carriage. The slide bearings are spring loaded against the machine to cause an optimum preset climbing resistance.

The routine maintenance of the VersaClimber is very simple. You can extend the life of the machine, maintain its appearance and smooth climbing motion by following these few easy steps.

CLEANLINESS

People that exercise on the VersaClimber will perspire. After every exercise session, wipe all surfaces clean with a damp cloth. Perspiration has a high salt content and is corrosive. Routine cleaning will prevent the painted surfaces from rusting or corroding.

LUBRICATION

There are 4 slide and roller bearing units that slide up and down inside of the vertical post structure to which the handgrips and foot pedals are attached.

The slides (image below) and the inner post surfaces are lubricated at the factory. When the lubricant on the inner surfaces of the post accumulates dust and/or dries out, a thick tar like substance can form that causes the machine to feel STICKY which may increase the resistance to slide freely. When this occurs the machine can be made to run like brand new by cleaning the inner tracks.

NOTE:

DO NOT use petroleum-based products such as motor oil or grease for re-lubing.
DO NOT use WD-40

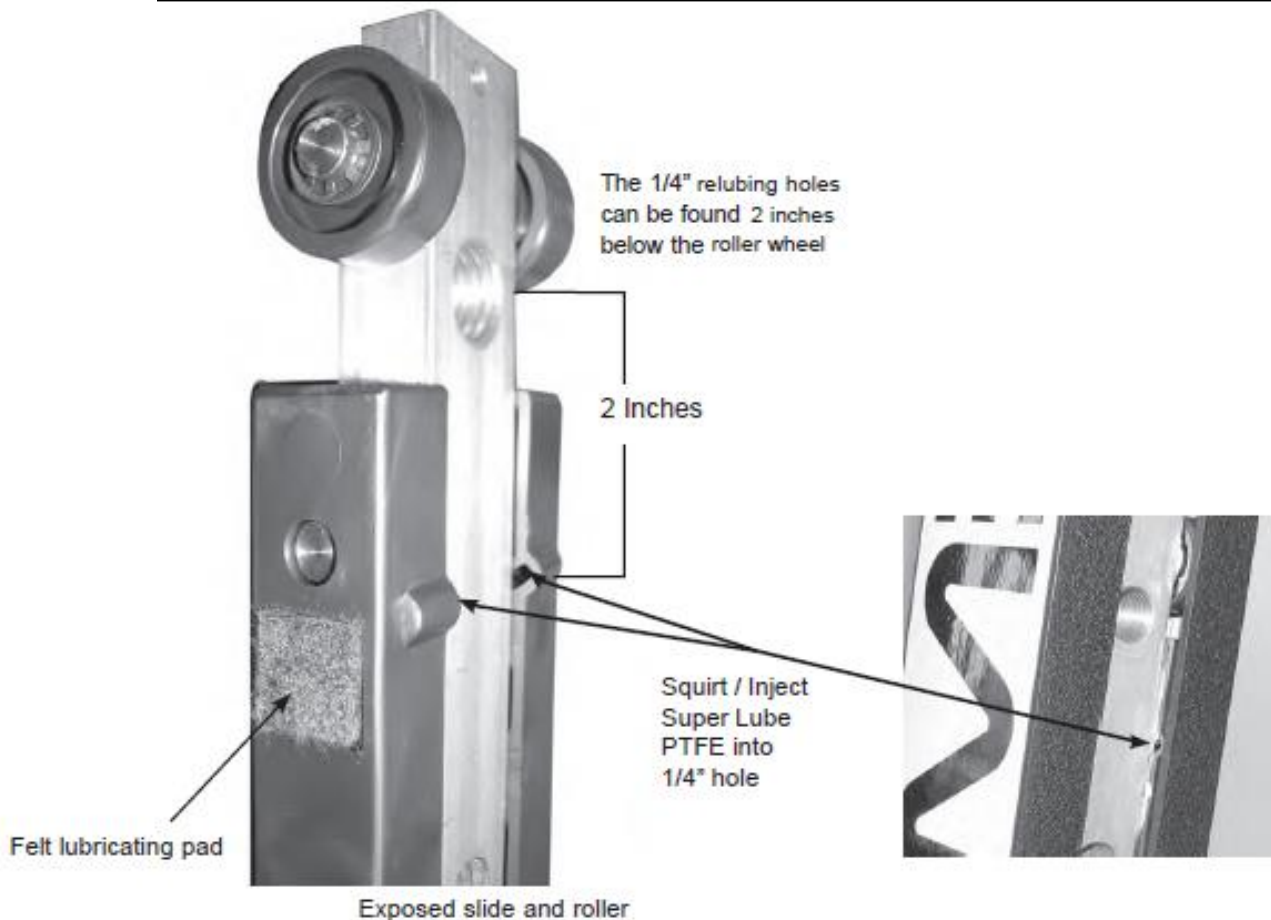



When the resistance seems to have increased or movement begins to feel "sticky", wipe all upper and lower inner surfaces with paint thinner to remove dry "gummy" lubricant build up.

If machine feels "sticky" or resistance increases use paint thinner in a spray bottle or on a rag to remove the thick lubricant from the inner-tracks. Wipe all upper and lower inner surfaces with paint thinner to remove dry lubricant. Move the machine through 20 -30 full cycles (pushing and pulling on the handles) and clean again. Then, after all dry sticky lubricant has been removed, be sure to wipe down with dry clean rag any paint thinner residue.

RELUBING

It's not necessary to relube after the first cleaning. if after the second cleaning, or at any time thereafter, the slide surfaces become completely dry, relube with Planet Safe Lubricants. Please visit www.planetsafelubricants.com to purchase.



Note: *DO NOT use petroleum based products such as motor oil or grease for relubing. DO NOT use WD-40*



<https://planetsafelubricants.com/collections/versaclimber-lube>

For questions please call customer care at 1.800.237.2271 or email sraya@versaclimber.com

VERSACLIMBER LIMITED WARRANTY

1. Heart Rate, Inc. (H.R.I.) warrants to the original purchaser that our VersaClimbers are free from defects in material and workmanship under normal use and maintenance subject to the terms and conditions Hereafter set forth. Except for the above warranty, it is expressly agreed that NO WARRANTY OF MERCHANTABILITY OR FITNESS FOR A PARTICULAR PURPOSE or of a particular use nor any warranty of any kind whatsoever express, implied or statutory is made by Heart Rate Inc. (HRI)
2. This warranty does not cover any damage caused by misuse, tampering, negligence, accidents, abnormal conditions, lack of adequate maintenance or unauthorized service or alterations to the product.
3. Liability of H.R.I. is limited to either repair or replacement of the defective part or the replacement of the machine at the option of H.R.I. on an exchange basis, with the customer bearing all costs of shipping and handling to and from the factory.

Full warranty details please visit: <https://versaclimber.com/warranty/>



Need to talk to us?
Call 1-800-237-2271



email us: support@versaclimber.zendesk.com



VERSACLIMBER

1.800.237.2271 | 714.850.9716
VersaClimber 1411 E. Wilshire Ave. Santa Ana, CA 92705